

# use & care guide

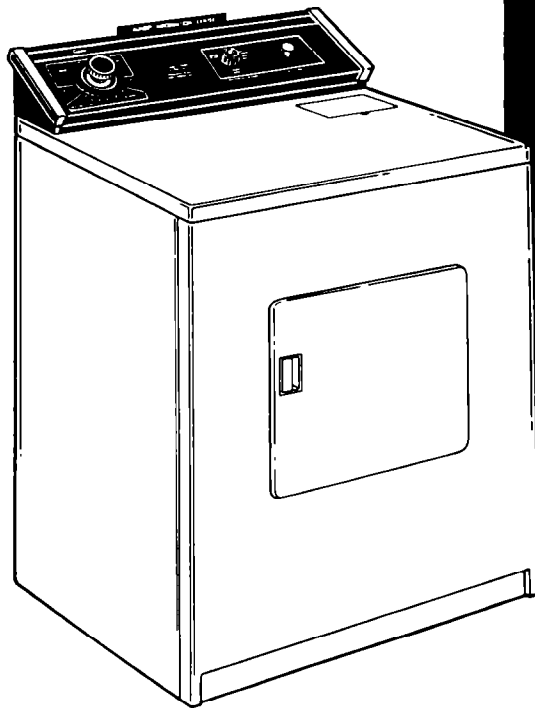

## **AUTOMATIC DRYERS**

**Gas Model  
3LG5706XP**

1-93

wave Ovens, Trash Compactors, Room Air Conditioners, Dehumidifiers, Automatic Washers, Clothes Dryers, Freezers, Refrigerator-Freezer

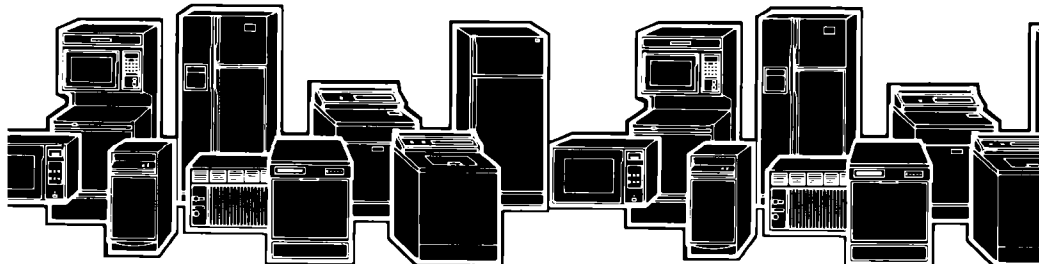

# Parts and features

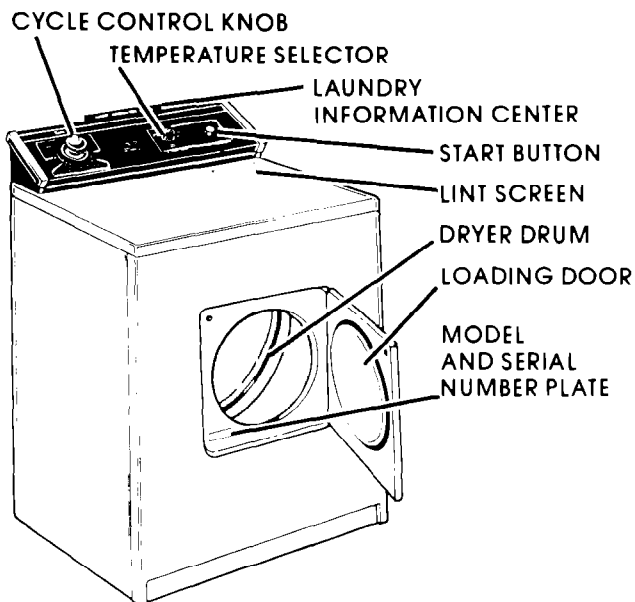

Remove the Consumer Buy Guide label before using your dryer. It will be easier to remove.

Wipe out the dryer drum with a damp cloth to remove dust from storing or shipping.

## Copy your Model and Serial Numbers here

When you need service or call with a question, have this information ready.

1. **Complete** Model and Serial Numbers (from the plate located as shown).
2. Purchase date from sales slip.

Copy this information in these spaces. Keep this book, your warranty, sales slip and "Dryer Guide" in the Laundry Information Center on the back of the dryer console.

There is no warranty registration to return. Proof-of-purchase is all that is required for in-warranty service.

\_\_\_\_\_ Complete Model Number

\_\_\_\_\_ Complete Serial Number

\_\_\_\_\_ Purchase Date

\_\_\_\_\_ Service Company and Telephone Number

## Contents

	Page		Page
<b>PARTS AND FEATURES</b> .....	2	<b>LINT SCREEN</b> .....	8
<b>YOUR RESPONSIBILITIES</b> .....	3	<b>LINT REMOVAL</b> .....	8
<b>SAFETY FIRST</b> .....	3	<b>CARING FOR YOUR DRYER</b> .....	9
<b>SELECTING A CYCLE AND STARTING YOUR DRYER</b> .....	4	Cleaning Dryer Interior .....	9
<b>OPERATING INSTRUCTIONS</b> ..	6	Vacation Care .....	9
Dryer Cycles and Settings ..	6	<b>IF YOU NEED SERVICE OR ASSISTANCE</b> .....	10
Cool Down Times .....	6	1. Before Calling for Assistance .....	10
<b>DRYING TIPS</b> .....	7	2. If You Need Assistance ..	11
FLUFF AIR Setting .....	7	3. If You Need Service .....	11
TUMBLE PRESS® Setting .....	7	4. If You Have a Problem ...	11
Mixed Loads .....	7		
Drying Times .....	7		

# Your Responsibilities

Read this "Use and Care Guide" and your "Dryer Guide" carefully for important use and safety information.

You are personally responsible for making sure that your dryer...

- is installed by a qualified installer.
- is properly maintained.
- is installed in an area protected from the weather.
- is properly installed and leveled in a well ventilated room\* on a floor that can support the weight.

- is located in an area where the temperature is above 45°F (7.2°C).
- is connected to the right kind of outlet, electric supply and grounding.\*
- is properly connected to fuel and exhaust systems.\*
- is used only for jobs normally expected of home clothes dryers.
- is not run where there may be explosive fumes.
- is not used by children or anyone unable to operate it properly.

\*See the "Installation Instructions" for complete information.

## Safety first

**ALWAYS** unplug the power supply cord or turn off electrical power before attempting to service the dryer. **Shut off the GAS VALVE** if yours is a gas dryer.

**ALWAYS** shut off the gas valve before leaving on vacation.

**NEVER** use flammable fluids (dry-cleaning solvents, gasoline, kerosene) in or near your dryer.

**ALWAYS** hand launder or air dry fabrics treated with flammable fluids before putting them into your dryer.

**NEVER** dry items containing wax or paint in the dryer. The fumes can create a **FIRE HAZARD**.

**FIRE HAZARD** and **DAMAGE** to some materials can result from:

- drying heat-sensitive materials with heat (see page 4).
- operating the dryer with the lint screen loose, damaged or missing.
- allowing lint to build up inside the dryer (see page 8).

**NEVER** allow children to operate, play with, or crawl inside the dryer.

**NEVER** operate the dryer if...

- it is not working right.
- it is damaged.
- parts are missing.
- all panels are not in place.

**DO NOT** let dust, lint, paper, rags, chemicals, etc., pile up around or under the dryer. **DO NOT** install against drapes or curtains.

### • FOR YOUR SAFETY •

#### IF YOU SMELL GAS:

1. OPEN WINDOWS.
2. DON'T TOUCH ELECTRICAL SWITCHES.
3. EXTINGUISH ANY OPEN FLAME.
4. IMMEDIATELY CALL YOUR GAS SUPPLIER.

### • FOR YOUR SAFETY •

**DO NOT STORE OR USE GASOLINE OR OTHER FLAMMABLE VAPORS AND LIQUIDS IN THE VICINITY OF THIS OR ANY OTHER APPLIANCE.**

• SAVE THESE INSTRUCTIONS •

# Selecting a cycle and starting your dryer

Before starting your dryer, be sure laundry is sorted and loaded properly (see your "Dryer Guide").  
**Be sure the door is tightly closed.**

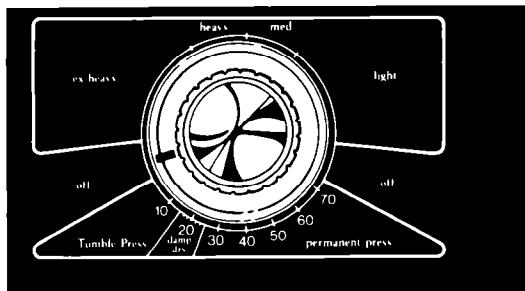

TYPE OF LOAD	SUGGESTED CYCLE	SUGGESTED TEMPERATURE
<b>COTTONS – LINENS</b>		
EXTRA HEAVY – Bedspreads, mattress pads, quilts	EX HEAVY	
HEAVYWEIGHT FABRICS – Towels, jeans, corduroys, work clothes	HEAVY	PERM'T PRESS HEAVY HIGH
MEDIUMWEIGHT COTTONS – Sheets, pillowcases, cotton underwear, diapers	MEDIUM	
LIGHTWEIGHT COTTONS – Batistes, organdies, lingerie	LIGHT	
<b>PERMANENT PRESS, SYNTHETICS AND BLENDS</b>		
HEAVYWEIGHT FABRICS – Work clothes, jackets, raincoats	40-50 MINS.	PERM'T PRESS HEAVY HIGH
MEDIUMWEIGHT FABRICS – Shirts, play clothes, sheets, slacks	30-40 MINS.	
LIGHTWEIGHT FABRICS – Lingerie, blouses, dresses	20-30 MINS.	
<b>KNITS</b>		
HEAVYWEIGHT – Cottons, rayons, blends, T-shirts, slacks, shirts	40-50 MINS.	PERM'T PRESS HEAVY HIGH
LIGHTWEIGHT – Synthetics (polyester, acrylic, etc.) and blends, lingerie, blouses, dresses	30-40 MINS.	KNITS GENTLE LOW
<b>LIGHTWEIGHT AND DELICATE FABRICS</b>		
Sheer Curtains (2 or 3 panels)	20-30 MINS.	KNITS GENTLE LOW
Gauze, lace, etc.	15-20 MINS.	
<b>RUBBER, PLASTIC, HEAT-SENSITIVE FABRICS</b>		
FOAM RUBBER – Pillows, bras, stuffed toys	20-30 MINS.	FLUFF AIR
PLASTIC – Shower curtains, tablecloths	20-30 MINS.	
RUBBER-BACKED RUGS	40-50 MINS.	
OLEFIN, POLYPROPYLENE, SHEER NYLON	15-20 MINS.	

**WARNING: Drying these and other heat-sensitive materials with heat can damage them or be a FIRE HAZARD.**

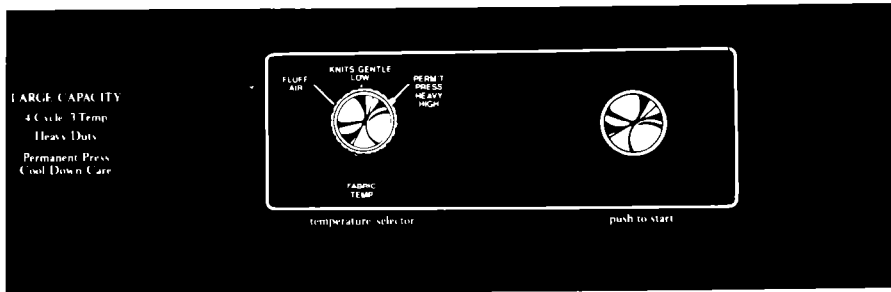

## Select a 1. CYCLE

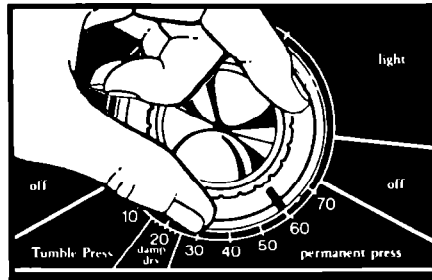

Turn the Control Knob either way to point to the cycle and setting you want. See page 6 for information on the cycles.

## Set TEMPERATURE 2. SELECTOR

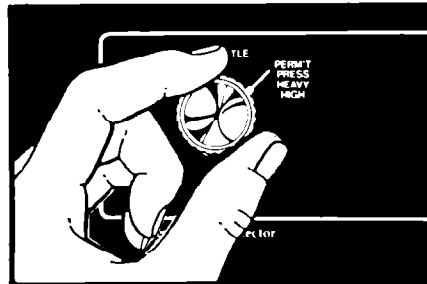

Turn the Temperature Selector to the needed drying temperature.

## Push the 3. START Button

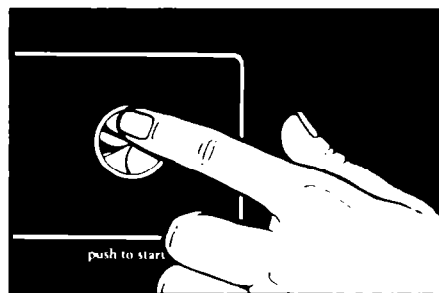

The dryer will start tumbling when you push the START Button.

## To stop and restart the dryer

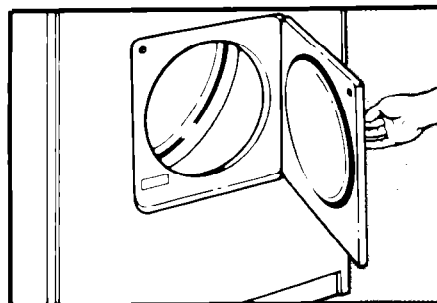

**To stop** the dryer, open the door (or turn the Control Knob to OFF).  
**To restart** the dryer, close the door, select cycle, if necessary, and push START.

**The Cycle Control Knob should point to OFF when the dryer is not in use.**

# Operating instructions

## Dryer cycles and settings

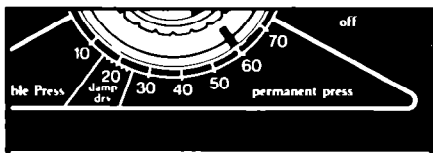

The PERMANENT PRESS Cycle helps provide the special care that permanent press and synthetic fabrics need...a period of heated drying followed by a 10 minute cool down. The chart on page 4 suggests time and temperature settings for different kinds of loads.

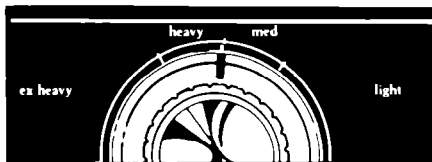

The **EX HEAVY, HEAVY, MEDIUM** and **LIGHT** cycles describe the loads they are designed to dry. The chart on page 4 tells what is meant by EX HEAVY, HEAVY, MEDIUM and LIGHT loads.

At each setting, the dryer will run about long enough to dry the load described by the setting. Example:

The HEAVY Cycle is designed to be long enough to dry a load of heavy fabrics (towels, jeans, corduroys, etc.) when the Temperature Selector is set on PERMIT PRESS/HEAVY HIGH.

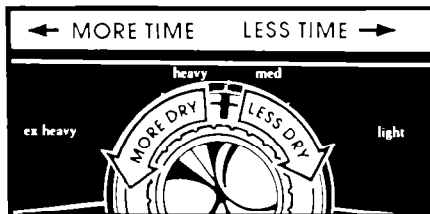

If the load is not as dry as you want, set the dial more to the **left** the next time you dry that kind of load.

If the load is dryer than you want, set the dial more to the **right** the next time you dry that kind of load.

## Cool down times

In all cycles, the heat shuts off before the dryer stops tumbling. This cool down time helps:

- keep wrinkles from setting in.
- make handling the hot load items easier.

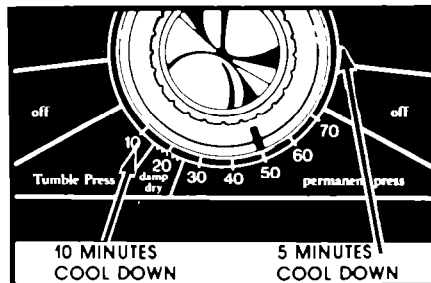

The PERMANENT PRESS Cycle has 10 minutes of cool down time at the end of the cycle.

All other cycles have 5 minutes of cool down time.

**Overdrying can cause shrinkage, static cling and damage to some fabrics.**

**To help reduce wrinkling, take the load from the dryer as soon as tumbling stops. This is very important for permanent press, knits and synthetic fabrics.**

## Drying tips

### FLUFF AIR

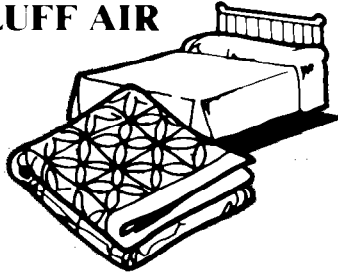

The dryer does not heat when the Temperature Selector is set on FLUFF AIR. This setting can be used to fluff bedding, plastic tablecloths, foam rubber pillows, stuffed toys, sneakers, etc.

1. Turn the Temperature Selector to FLUFF AIR.
2. Turn the Control Knob to the number of minutes you want in the TIMED DRYING Cycle.
3. Push the START Button.



**WARNING: Drying plastic or rubber items with heat may damage the items or be a FIRE HAZARD.**

### Mixed loads



When drying a load with different kinds and weights of fabrics, use the cycle suggested for the lightest fabrics. When the dryer stops, remove dry items and reset the control.

### TUMBLE PRESS® Setting

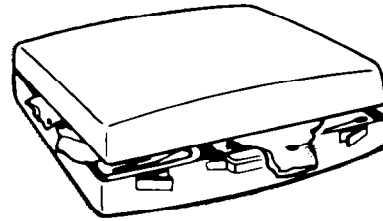

The TUMBLE PRESS setting removes wrinkles from dry clothing such as items that may have been packed in a suitcase, closet, or items not removed from the dryer.

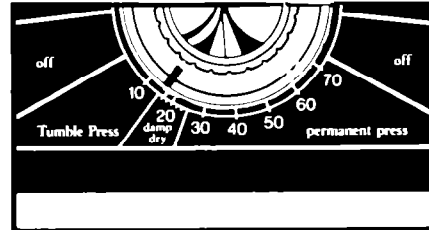

1. Set Temperature Selector to PERMIT PRESS / HEAVY HIGH.
2. Set Control Knob to TUMBLE PRESS.
3. Push START Button.

The load will tumble in heated air for 5 minutes. The heat shuts off and the dryer continues to tumble the load for 10 more minutes.

For best results, TUMBLE PRESS only a few items at a time. Put them on hangers or fold them as soon as the dryer stops.

### Drying times

Drying times will vary depending on

- amount of moisture in the clothes.
- type and weight of the fabric.
- size of the load.
- room temperature around the dryer.
- temperature of the wash rinse water.
- amount of lint in the lint screen.
- dryer temperature selection.

See page 6 in your "Dryer Guide" for more information.

## Lint screen

Clean the lint screen before each load. A screen blocked by lint can increase drying time and may be a FIRE HAZARD.

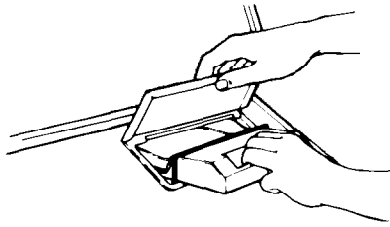

Open the lid and pull the lint screen straight out.

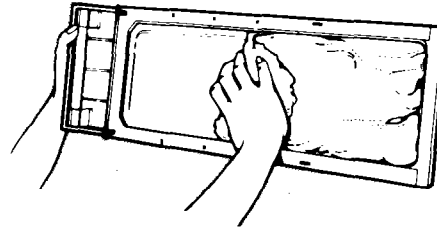

**ROLL** the lint off the screen with your fingers.

**DO NOT** rinse or wash the screen.

Push the screen firmly back into place.

 **WARNING: DO NOT** run the dryer with the lint screen loose, damaged or missing. Doing so can cause overheating, can damage fabrics and can be a **FIRE HAZARD**.

## Lint removal

Lint can gather inside the dryer and create a fire hazard. **This lint should be removed every 2 to 3 years, or more often, depending on dryer usage.**

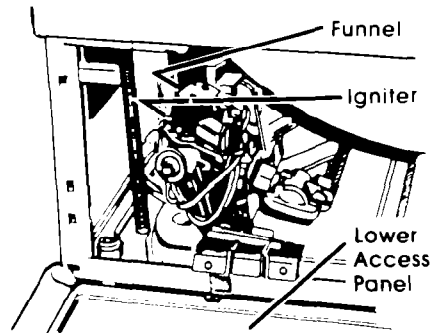

### GAS DRYERS

**Cleaning should be done only by a qualified person.**



#### **WARNING:**

- **Avoid electrical shock hazard – unplug power supply cord or turn off electrical power.**
- **Avoid injury or damage – do not put hands inside cabinet.**
- **Make sure dryer is cool.**

1. Remove lower access panel.
2. Avoid damaging wires, thermostats, funnel or igniter.
3. Remove lint from shaded area – see art – with a soft brush or vacuum cleaner.
4. Replace panel; reconnect and re-level dryer.



# Caring for your dryer

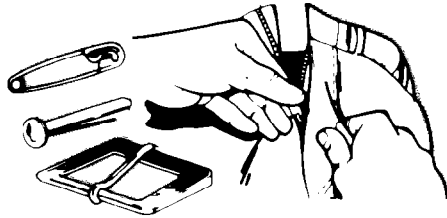

**Remove loose and sharp objects** from pockets and cuffs before drying – pins, buckles, etc. **Close metal zippers.**

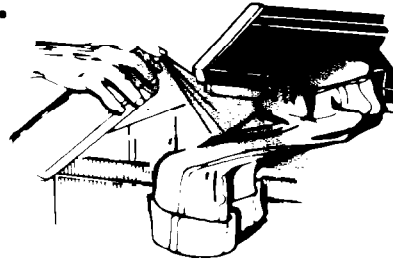

**Some pretreatment products** can damage dials, consoles and finish. Do not use these products on or near your dryer.



**Wipe off all spills** with a damp, soft cloth. Spills allowed to remain may dull or damage the finish.

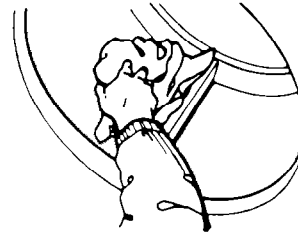

## Cleaning dryer interior



**Before cleaning interior,** unplug power supply cord or turn off electrical power to avoid electrical shock hazard.

Garments which contain unstable dyes, such as denim blue jeans or brightly colored cotton items, may discolor the dryer interior. If the interior is discolored, clean with one of the following methods to avoid staining later load items.

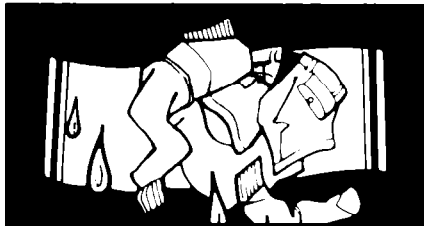

**Never** leave wet or damp laundry in your dryer.

### **Powdered laundry detergent and very warm water**

Make a paste with detergent and very warm water. Apply paste to a soft cloth and scrub area until all excess dye is removed. Wipe thoroughly with a damp cloth. Tumble a load of rags. –OR–

### **Liquid spray household cleaner**

Spray on stained area. Rub with a cloth until all excess dye is removed. Tumble a load of rags.

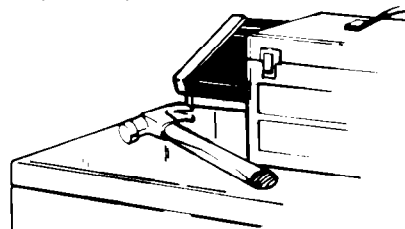

**Sharp or heavy objects** should never be put on or in the dryer. Check pockets for bolts, nuts, etc.

## Vacation care

- Unplug power cord or turn off electrical power.
- For gas dryers, close gas valve.
- Clean lint screen.

# If you need service or assistance, we suggest you follow these steps:

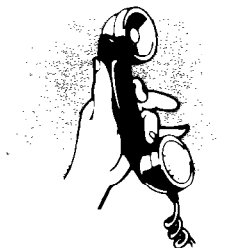

## Before calling for assistance...

Performance problems often result from little things you can find and fix yourself without tools of any kind.

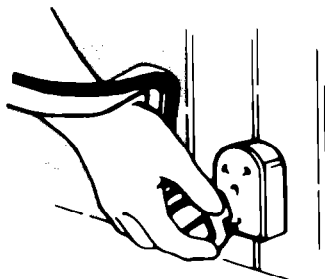

### If your dryer does not run:

- If the power supply cord plugged into a live circuit with the proper voltage?
- Is the door closed tightly?
- Did you push the START Button?

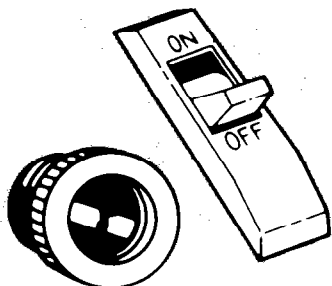

- Have you checked your home's main fuses or circuit breaker box?

### If your dryer does not heat:

- The AIR setting is without heat.
- The last minutes of heat settings are without heat.

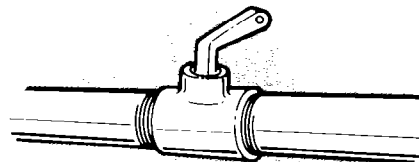

- Is the gas turned on? If not, turn the Control Knob to OFF. Turn on gas. Wait 5 minutes. Reset controls and start.
- An electric dryer uses a circuit breaker or 2 fuses. If one fuse is blown, the dryer may run, but not heat.

### If drying time seems long:

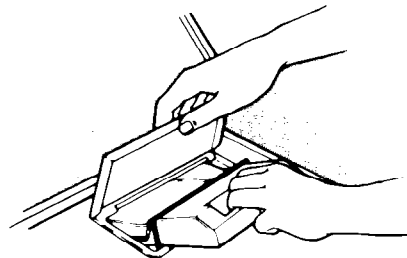

- Is the lint screen clean?
- See page 7 of this book and page 6 of your "Dryer Guide."

## If you move...

To make sure that your appliance is correctly installed and to insure its continued satisfactory operation, call your dealer. (Installation cost must, of course, be paid by you.)

## Helpful hints...

You can help your service representative give you faster service if you include the model and serial number of your appliance when requesting service. Also, retain your sales slip and warranty to verify your warranty status.

**Remember...** Your service representative is trained in repairing and servicing your Whirlpool appliances. He can help you maintain the quality originally built into your WHIRLPOOL appliance. So...take the time now to look up his telephone number and jot it down in the space provided on page 2.

## If you have a problem:\*

Call your dealer or write:  
Service Manager,  
International Division  
Whirlpool Corporation  
Administrative Center  
2000 US-33 North  
Benton Harbor, Michigan 49022

\*If you must write, please provide: your name, address, telephone number, type of appliance, brand, model, serial number, the dealer's name and a complete description of the problem. This information is needed in order to better respond to your request for assistance.



FSP is a registered trademark of Whirlpool Corporation for quality parts. Look for this symbol of quality whenever you need a replacement part for your Whirlpool appliance. FSP replacement parts

will fit right and work right, because they are made to the same exacting specifications used to build every new Whirlpool appliance

IF YOU NEED SERVICE OR ASSISTANCE



Making your world a little easier.

Part No. 696764  
©1985 Whirlpool Corporation

Printed in U.S.A.

omatic Washers, Clothes Dryers, Freezers, Refrigerator-Freezers, Ice Makers, Dishwashers, Built-In Ovens and Surface Units, Ranges, W

